



register and win!
www.kärcher.com



KÄRCHER®

KB 3.99 M

Operating Instructions

Before using the unit for the first time, please read and comply with these Operating Instructions



5.961-253.0 03/08

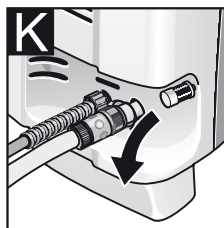
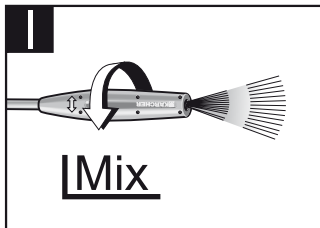
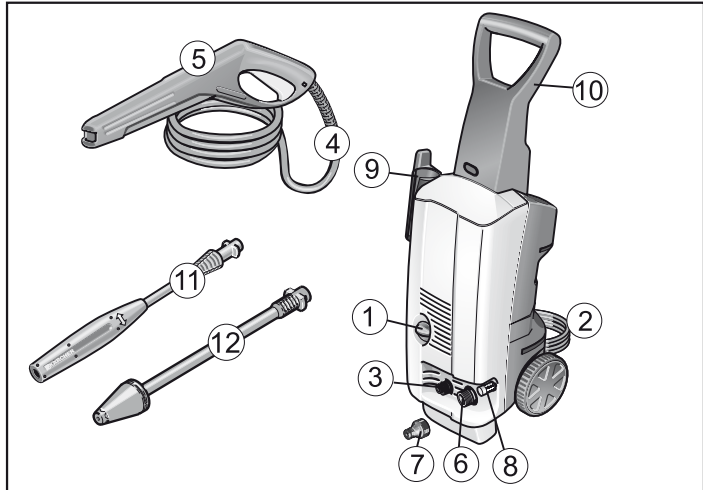
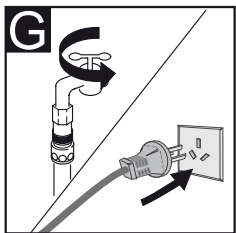
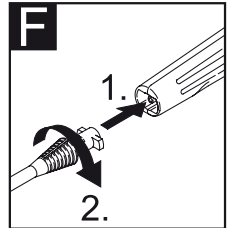
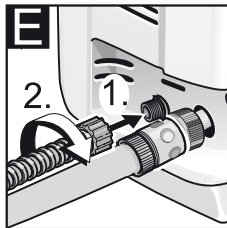
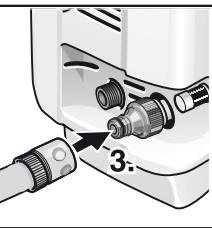
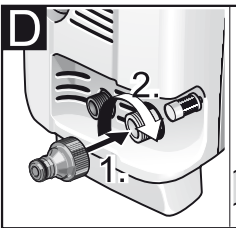
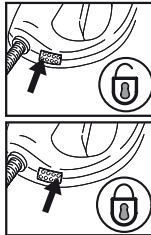
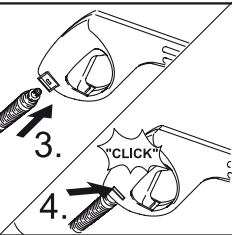
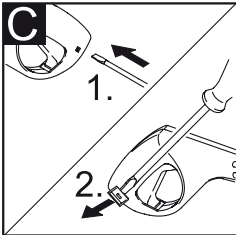
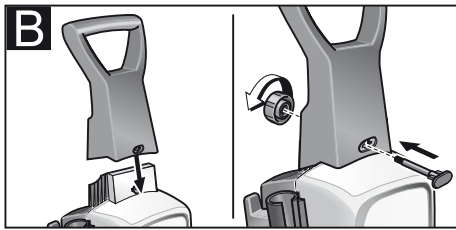
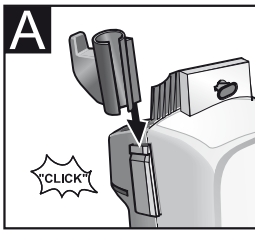

Dear Customer,



Please read and comply with these instructions prior to the initial operation of your appliance. Retain these operating instructions for future reference or for subsequent possessors.

Contents

General information	3
Safety instructions	4 - 5
Commissioning and operation	6 - 8
Maintenance and care	8
Troubleshooting	9
Specifications	10

General information

Hazard levels

Danger

Immediate danger that can cause severe injury or even death.

Warning

Possible hazardous situation that could lead to severe injury or even death.

Caution

Possible hazardous situation that could lead to mild injury to persons or damage to property.

Proper Use

This high-pressure cleaner is designed for domestic use only:

- to clean machines, vehicles, buildings, tools, facades, terraces, garden equipment etc. using a high-pressure water jet (and detergents if required).
- with accessories, replacement parts and detergents approved by Kärcher. Observe the instructions provided with these detergents.

Environmental protection



The packaging material can be recycled. Please do not place the packaging into the ordinary refuse for disposal, but arrange for the proper recycling.



Old appliances contain valuable materials that can be recycled. Please arrange for the proper recycling of old appliances. Please dispose your old appliances using appropriate collection systems

Warranty

The warranty terms published by our competent sales company are applicable in each country. We will repair potential failures of your appliance within the warranty period free of charge, provided that such failure is caused by faulty material or defects in fabrication. In the event of a warranty claim please contact your dealer or the nearest authorized Customer Service center. Please submit the proof of purchase.

Safety instructions

⚠ Danger

- Never touch the mains plug and the socket with wet hands.
- The appliance must not be used if the power cord or important parts of the appliance, e.g. high-pressure hoses, trigger gun or safety devices are damaged.
- Check the power cord with mains plug for damage before every use. If the power cord is damaged, please arrange immediately for the exchange by an authorized customer service or a skilled electrician.
- Check the high-pressure hose for damage before every use. Please arrange for the immediate exchange of a damaged high-pressure hose.
- The appliance may not be used in areas where a risk of explosion is present.
- If the appliance is used in hazardous areas (e.g. filling stations) the corresponding safety provisions must be observed.
- High-pressure jets can be dangerous if improperly used. The jet must not be directed at persons, animals, live electrical equipment or at the appliance itself.
- The high-pressure jet must not be directed at other persons or directed by the user at him/herself to clean clothing or footwear.
- Never use the appliance to clean objects containing hazardous substances (e.g. asbestos).
- Vehicle tyres or tyre valves are susceptible to damage from the high-pressure jet and may burst. The first indication of this is a discolouration of the tyre. Damaged vehicle tyres/tyre valves are highly dangerous. Ensure that a distance of at least 30 cm is observed when cleaning with the jet!



- Never draw in fluids containing solvents or undiluted acids and solvents! This includes petrol, paint thinner and heating oil. The spray mist thus generated is highly inflammable, explosive and poisonous. Do not use acetone, undiluted acids and solvents as they are aggressive towards the materials from which the appliance is made.

⚠ Warning

- This device is not intended for use by persons (including children) with reduced physical, sensory or mental abilities or lacking experience and/or knowledge, unless they are supervised by a person responsible for their safety or are instructed by these persons on the use of the device. Children should be supervised, to ensure that they do not play with the device.
- The mains plug and the coupling of an extension cable must be watertight and must never lay in the water.
- Unsuitable extension cables can be hazardous. Only use extension cables outdoors which have been approved for this purpose and labelled with a sufficient cable cross-section: 1 - 10 m: 1.5 mm²; 10 - 30 m: 2.5 mm²
- Always fully unroll electrical cables from the cable drum.
- High-pressure hoses, fixtures and couplings are important for the safety of the appliance. Only use high-pressure hoses, fixtures and couplings recommended by the manufacturer.
- The operator must use the appliance correctly. When working with the appliance, he must consider the local conditions and pay due care and attention to other persons, in particular children, who are nearby.
- Do not use the appliance when there are other persons around unless they are also wearing safety equipment.

- *Wear protective clothing and safety goggles to protect against splash back containing water or dirt.*

Caution

- *Observe a distance of at least 30 cm when using the jet to clean painted surfaces to avoid damaging paintwork.*
- *Never leave the appliance unattended when it is in operation.*
- *Make sure that the power cable or extension cables are not damaged by running over, pinching, dragging or similar. Protect the power cable from heat, oil, and sharp edges.*
- *All current-conducting parts in the working area must be protected against jet water.*
- *The appliance may only be connected to an electrical supply which has been installed in accordance with IEC 60364.*
- *The appliance may only be connected to alternating current. The voltage must correspond with the type plate on the appliance.*
- *The maximum tolerable mains impedance at the electrical contact point (see Technical Data) must not be exceeded.*
- *For safety reasons, we recommend that you operate the appliance only via a earth-leakage circuit breaker (max. 30 mA).*
- *Cleaning operations which produce oily waste water, e.g. engine washes, underbody washes, may only be carried out using washing stations equipped with an oil separator.*
- *This appliance was designed to be used with detergents which are supplied or recommended by the manufacturer. The use of other detergents or chemicals may compromise the safety of the appliance.*

Safety Devices

Caution

Safety devices protect the user and must not be modified or bypassed.

Power switch

The appliance switch prevents unintentional operation of the appliance.

Lock trigger gun

This lock locks the lever of the trigger gun and prevents the inadvertent start of the appliance.

Commissioning and operation

Description of the Appliance

When unpacking the product, make sure that no accessories are missing and that none of the package contents have been damaged. If you detect any transport damages please contact your dealer.

Illustrations on Page 2

- 1 ON/OFF switch for appliance
- 2 Power cable with plug
- 3 High pressure connection
- 4 High pressure hose
- 5 Trigger gun with safety catch
- 6 Connection for water supply with filter
- 7 Coupling element for water connection
- 8 Suction hose for detergent
- 9 Storage for trigger gun
- 10 Transport handle
- 11 Spray lance with pressure regulation (Vario Power)
- 12 Spray lance with dirt blaster

Special accessories

Special accessories expand the possibilities of using your appliance. Please contact your Kärcher dealer for further information.

Before Startup

Illustration **A** - **B**

Mount loose parts delivered with appliance prior to start-up.

Illustration **C**

- Pull out the clamp for the high-pressure hose from the trigger gun (e.g. a small screwdriver).
- Connect high pressure hose to trigger gun.
- Push the clamp in until it locks. Check the secure connection by pulling on the high-pressure hose.

Water supply

According to the applicable regulations, the appliance must never be used on the drinking water supply without a system separator. Use a suitable system separator manufactured by Kärcher; or, as an alternative, a system separator as per EN 12729 Type BA.



Note: Impurities in the water can damage the high-pressure pump and accessories. For protection, the use of the Kärcher water filter (optional accessory, order no. 4.730-059) is recommended.

Water supply from mains

Observe regulations of water supplier. For connection values, see type plate/technical data.

- Use a fibre-reinforced water hose (not included) with a standard coupling. (Minimum diameter 1/2 inch (13 mm), minimum length 7.5 m).

Illustration **D**

- Screw the coupling unit (supplied) to the water connection on the appliance.
- Push the water supply hose onto the coupling unit, then connect it to the water supply.

Drawing in water from open reservoirs

This high-pressure cleaner is suited to work with the Kärcher suction hose with backflow valve (Optional accessory, order no. 4.440-238) to draw in surface water, e.g. from water butts or ponds (see specifications for max. suction height).

- Fill the Kärcher suction hose with backflow valve with water, screw to water supply and hang into the water butt.
- Separate the high pressure hose from the high pressure connection point of the appliance.
- Switch the appliance on "I/ON" and operate until the water exits the high-pressure connection without bubbles.
- Turn off the appliance "0/OFF".

Start up

Caution

Never operate the high-pressure cleaner when the tap is turned off as dry running will damage the high-pressure pump.

Illustration 

→ Connect the high pressure hose to the high pressure connection of the appliance.

Illustration 

→ Push the spray lance into the trigger gun and fasten it by turning it through 90°.

Illustration 

→ Completely open the water tap.

→ Insert the mains plug into the socket.

Illustration 

→ Turn on the appliance "I/ON".

Operation

Danger

The trigger gun is subjected to a recoil force when the water jet is discharged. Make sure that you have a firm footing and are also holding the trigger gun and spray lance firmly.

→ Unlock the lever on the trigger gun.

→ Pull on the lever of the trigger gun; the device will switch on.

Note: Release the lever of the trigger gun; the device will switch off again. High pressure remains in the system.

Spray lance with pressure regulation

Carrying out the most common cleaning tasks. The work pressure can be stagelessly regulated between "Min" and "Max".

→ Release the lever on the trigger gun.

→ Turn the spray lance to the desired position.

Spray lance with dirt blaster

For particularly dirty items or areas.

Not suitable for use with detergents.

Operation with detergent

We recommend the Kärcher cleaning and care program that will match the respective cleaning requirements. Please seek consultation or request information on the subject.

→ Use spray lance with pressure regulation (Vario Power).

Illustration 

→ Turn the spray lance to "Mix" position - low pressure.

Illustration 

→ Pull detergent suction hose as far as is required out of the housing.

→ Suspend end of detergent suction hose in a container filled with detergent.

Recommended cleaning method

→ Spray the detergent sparingly on the dry surface and allow it to react, but not to dry.

→ Spray off loosened dirt with the high-pressure ray.

Interrupting operation

→ Release the lever on the trigger gun.

→ Lock the lever on the trigger gun.

→ During longer breaks (more than 5 minutes), also turn the appliance off using the "0/OFF" switch.

→ Insert the trigger gun in its holder.

Finish operation

Caution

Only separate the high-pressure hose from the trigger gun or the appliance while there is no pressure in the system.

- After working with detergent, suspend detergent suction hose in a container filled with clear water, switch the appliance on for around 1 minute once the spray lance has been removed and rinse until water runs clear.
- Release the lever on the trigger gun.
- Turn off the appliance "0/OFF".
- Turn off tap.
- Detach the appliance from the water supply.
- Press the lever on the trigger gun to release any remaining pressure in the system.
- Lock the lever on the trigger gun.
- Pull out the mains plug.
- Roll up the power cord and loop it e.g. round the handle.
- Insert the trigger gun in its holder.
- Stow away the mains cable, the high-pressure hose and accessory at the appliance.

Maintenance and care

Danger

Turn off the appliance and remove the mains plug prior to any care and maintenance work.

Maintenance

The appliance is maintenance-free.

Storage

Prior to longer periods of storage, e.g. in the winter:

- Completely drain all water from the appliance: Switch the appliance on with detached high-pressure hose and detached water supply (max. 1 minute) and wait, until no more water exits at the high-pressure connection. Turn off the appliance.
- Remove filter from suction hose for detergent and clean under running water.
- Pull out the sieve in the water connection using flat-nose pliers and clean under running water.

Frost protection

Caution

Protect the appliance and its accessories against frost.

The appliance and its accessories can get destroyed through frost if there are any water residues in them. To avoid damage to them:

- Store the appliance and the entire accessories in a frost-safe room.

Spare parts

Use only original Kärcher spare parts. You will find a list of spare parts at the end of these operating instructions.

Troubleshooting

You can rectify minor faults yourself with the help of the following overview.

If in doubt, please consult the authorized customer service.

Danger

Turn off the appliance and remove the mains plug prior to any care and maintenance work.

Repair works may only be performed by the authorized customer service.

Appliance is not running

- Check whether the voltage indicated on the type plate corresponds to the voltage of the mains supply.
- Check the mains connection cable for damages.

Pressure does not build up in the appliance

- Check setting at the spray lance.
- Appliance ventilation: Switch the appliance on with the high-pressure hose detached and operate until the water flows through the high-pressure connection without bubbles. Switch off appliance and reconnect high-pressure hose.
- Check the water supply.
- Pull out the sieve in the water connection using flat-nose pliers and clean under running water.

Appliance does not start, motor hums

Cause: Voltage reduction due to weak mains supply or when using an extension cable.

- When switching on, first pull the lever of the trigger gun and then switch the appliance switch to "I/ON".

Strong pressure fluctuations

- Clean high-pressure nozzle: Remove dirt and debris from the nozzle bore, using a needle and rinse through with water from the front.
- Check water flow quantity.

Appliance is leaking

- Slight leakage from the appliance pump is normal. If the leakage increases contact the authorized customer service.

No detergent infeed

- Use spray lance with pressure regulation (Vario Power).
Turn the spray lance to "Mix" position.
- Clean the detergent suction hose filter.
- Check the detergent suction hose for kinks.

Specifications

Power connection

Voltage 230 - 240 V

1~50 Hz

Connected load 1,7 kW

Mains fuse (slow-blow) 10 A

Protective class I

Protection class IP X5

Water connection

Max. feed temperature 40 °C

Min. feed volume 10 l/min

Max. feed pressure 1,2 MPa

Performance data

Working pressure 11 MPa

Max. permissible pressure 12 MPa

Water flow rate 6,3 l/min

Detergent flow rate 0,3 l/min

Recoil force of trigger gun 15 N

Hand-arm vibration
(ISO 5349) 0,8 m/s²

Sound pressure level 74,5 dB(A)

L_{pA} (EN60704-1)

Sound power level 87 dB(A)

L_{WA} (2000/14/EG)

Dimensions

Length 290 mm

Width 340 mm

Height 805 mm

Weight 12,2 kg

Subject to technical modifications!

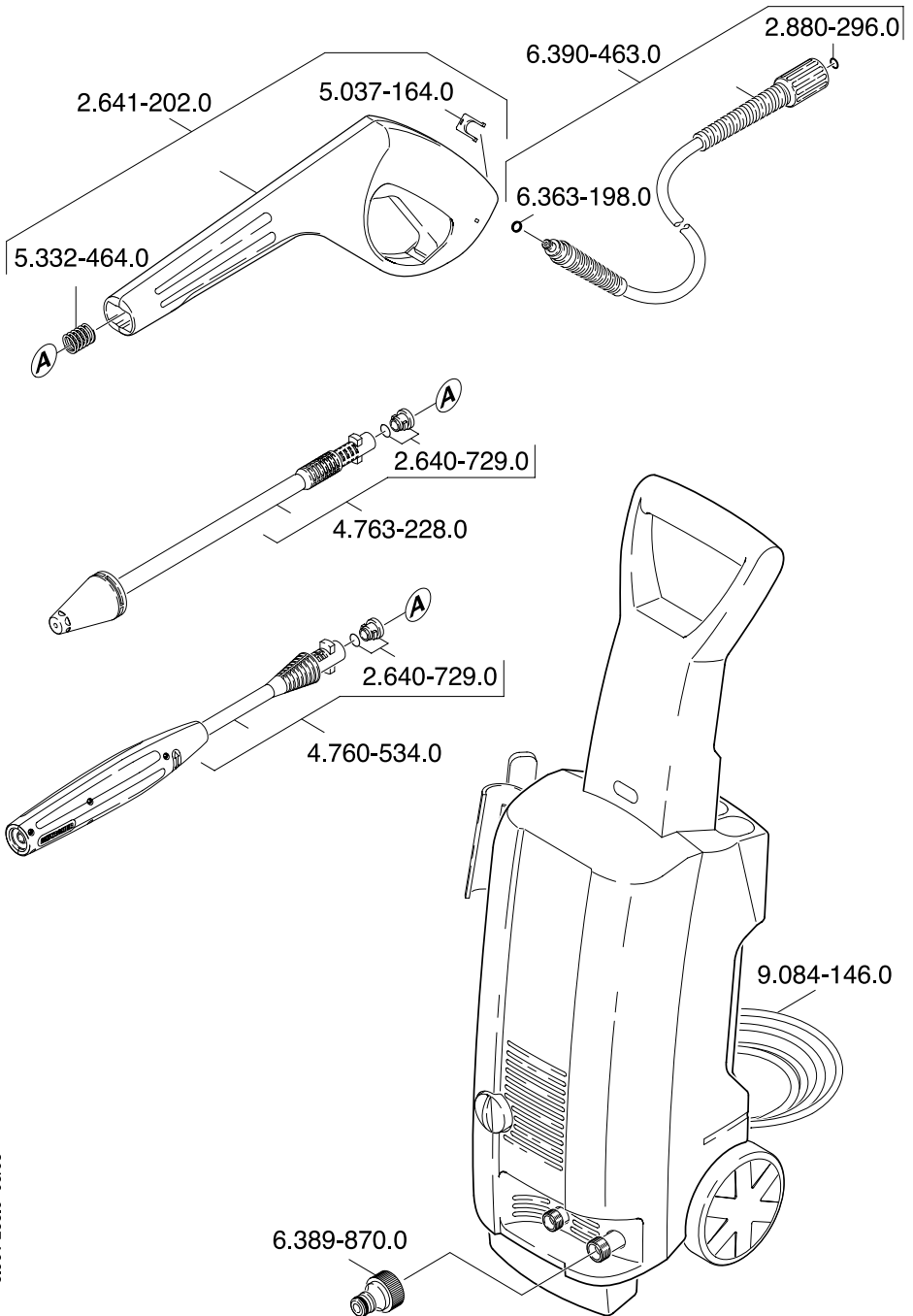

5.961-253.0 03/08

A

Alfred Kärcher Ges.m.b.H.
Lichtblaustraße 7
1220 Wien
☎ (01) 25 06 00

AUS

Kärcher Pty. Ltd.
40 Koornang Road
Scoresby VIC 3179
☎ (03) 9765 - 2300

B / LUX

Kärcher N.V.
Industrieweg 12
2320 Hoogstraten
☎ 0900 - 33 444 33

BR

Kärcher Indústria e Comércio Ltda.
Av. Prof. Benedicto Montenegro 419
CEP 13.140-000 - Paulínia - SP
☎ 0800 17 61 11

CH

Kärcher AG
Industriestraße 16
8108 Dällikon
☎ 0844 850 863

CZ

Kärcher spol. s.r.o.
Za Mototechnou 1114/4
155 00 Praha 5 -Stodůlky
☎ (02) 3552-1665

D

Alfred Kärcher GmbH & Co. KG
Service-Center Gissigheim
Im Gewerbegebiet 2
97953 Königheim-Gissigheim
☎ (07195) 903 20 65

DK

Kärcher Rengøringsystemer A/S
Gejlhavegård 5
6000 Kolding
☎ 70 20 66 67

E

Kärcher S.A.
Pol. Industrial Font del Radium
Calle Doctor Trueta 6-7
08400 Granollers (Barcelona)
☎ 902 17 00 68

F

Kärcher S.A.S.
5 Avenue des Coquelicots
Z.A. des Petits Carreaux
94865 Bonneuil-sur-Marne
☎ (01) 43 99 67 70

FIN

Kärcher OY
Yrittäjätie 17
01800 Klaukkala
☎ 0207 413 600

GR

Kärcher Cleaning Systems A.E.
31-33, Nikitara & Konstantinoupoleos str.
13671 Acharnes
☎ 210 - 23 16 153

GB

Kärcher(UK) Limited
Kärcher House
Beaumont Road
Banbury
Oxon, OX16 1TB
☎ 01295 752200

H

Kärcher Hungária Kft
Tormásrét ut. 2.
2051 Biatorbágy
☎ (023) 530-640

HK

Kärcher Limited
Unit 10, 17/F.
APEC Plaza
49 Hoi Yuen Road
Kwun Tong, Kowloon
☎ (02) 357-5863

I

Kärcher S.p.A.
Via A. Vespucci 19
21013 Gallarate (VA)
☎ 848 - 99 88 77

IRL

Kärcher Limited (Ireland)
12 Willow Business Park
Nangor Road
Clondalkin
Dublin 12
☎ (01) 409 77 77

KOR

Kärcher Co. Ltd. (South Korea)
Youngjae B/D, 50-1, 51-1
Sansoo-dong, Mapo-ku
Seoul 121-060
☎ 032-465-8000

MAL

Kärcher Cleaning Systems Sdn. Bhd.
No. 8, Jalan Serindit 2
Bandar Puchong Jaya
47100 Puchong, Selangor
☎ (03) 5882 1148

N

Kärcher AS
Stanseveien 31
0976 Oslo
☎ 24 17 77 00

NL

Kärcher BV
Postbus 474
4870 AL Etten-Leur
☎ 0900-33 444 33

NZ

Kärcher Limited
12 Ron Driver Place
East Tamaki, Auckland
☎ (09) 274-4603

PRC

Kärcher Cleaning Systems Co., Ltd.
Part B, Building 30,
No. 390 Ai Du Road
Shanghai Waigaoqiao 200131
☎ (021) 5046-3579

P

Neoparts Com. e Ind. Automóvel, Lda.
Largo Vitorino Damásio. 10
1200 Lisboa
☎ (21) 395 0040

PL

Kärcher Sp. z o.o.
Ul. Stawowa 140
31-346 Kraków
☎ (012) 6397-222

RUS

Kärcher Ltd.
Vienna House
Strastnoi Blv. 16
107031 Moscow
☎ 095-933 87 48

S

Kärcher AB
Tagenevägen 31
42502 Hisings-Kärä
☎ (031) 577-300

SGP

Kärcher Asia Pacific Pte. Ltd.
5 Toh Guan Road East
#01-00 Freight Links Express Distripark
Singapore 608831
☎ 6897-1811

TR

Kärcher Servis Ticaret A.S.
9 Eylül Mahallesi
307 Sokak No. 6
Gaziemir / Izmir
☎ (0232) 252-0708

TWN

Kärcher Limited
5F/6. No.7
Wu-Chuan 1st Rd
Wu-Ku Industrial Zone
Taipei County
☎ (02) 2299-9626

UA

Kärcher Ukraine
Kilzeva doroga, 9
03191, Kyiv
☎ (044) 5947575

UAE

Kärcher FZE
Jebel Ali Free Zone
RA 8, XB 1, Jebel Ali, Dubai
☎ (04) 8836-776

ZA

Kärcher (Pty.) Limited
144 Kuschke Street
Meadowdale
Edenvale 1614
☎ (011) 574-5360

02/2008



www.kaercher.com